

User's Guide

Dell S2317HJ

Model No.: S2317HJ

Regulatory model: S2317HJb



Notes, Cautions, and Warnings



NOTE: A NOTE indicates important information that helps you make better use of your computer.



CAUTION: A CAUTION indicates potential damage to hardware or loss of data if instructions are not followed.



WARNING: A WARNING indicates a potential for property damage, personal injury or death.

Information in this document is subject to change without notice.

© 2016 Dell Inc. All rights reserved.

Reproduction of these materials in any manner whatsoever without the written permission of Dell Inc. is strictly forbidden.

Trademarks used in this text: *Dell* and the *DELL* logo are trademarks of Dell Inc.; *Microsoft* and *Windows* are either trademarks or registered trademarks of Microsoft Corporation in the United States and/or other countries; *Intel* is a registered trademark of Intel Corporation in the U.S. and other countries; and *ATI* is a trademark of Advanced Micro Devices, Inc.

Other trademarks and trade names may be used in this document to refer to either the entities claiming the marks and names or their products. Dell Inc. disclaims any proprietary interest in trademarks and trade names other than its own.

Contents

About Your Monitor	5
Package Contents	5
Product Features	6
Identifying Parts and Controls	8
Plug and Play Capability.....	12
LCD Monitor Quality and Pixel Policy.....	12
Maintenance Guidelines	12
Setting Up the Monitor.....	13
Connecting the Stand	13
Connecting Your Monitor	14
Organizing Cables.....	15
Removing the Monitor Stand.....	16
Operating Your Monitor.....	17
Power On the Monitor	17
Using the Front Panel Controls.....	17
Using the On-Screen Display (OSD) Menu.....	19

Setting the Maximum Resolution.....	32
Using the Tilt	33
Using the Wireless Charging Base	34
Troubleshooting.....	37
Self-Test	37
Built-in Diagnostics.....	38
Common Problems	39
Product-Specific Problems	41
Wireless Charging Specific Problems	41
Appendix	42
FCC Notices (U.S. Only) and Other Regulatory Information	42
Contact Dell	42
Setting Up Your Monitor	43
Monitor Specifications	45



About Your Monitor

Package Contents

Your monitor ships with the components shown below. Ensure that you have received all the components and [Contact Dell](#) if something is missing.

 **NOTE:** Some items may be optional and may not ship with your monitor. Some features or media may not be available in certain countries.

	<ul style="list-style-type: none">• Monitor
	<ul style="list-style-type: none">• Stand Riser
	<ul style="list-style-type: none">• Wireless Charging Base
	<ul style="list-style-type: none">• Power Adapter
	<ul style="list-style-type: none">• Power Cable (varies by country)

	<ul style="list-style-type: none"> • HDMI Cable
	<ul style="list-style-type: none"> • Drivers and Documentation Media • Quick Setup Guide • Safety and Regulatory Information • Wireless Safety and Regulatory Information

Product Features

The **Dell S2317HJ** flat panel display has an active matrix, Thin-Film Transistor (TFT), Liquid Crystal Display (LCD), and LED backlight. The monitor features include:

- 58.42 cm (23 inch) viewable area display (measured diagonally). 1920 x 1080 resolution, plus full-screen support for lower resolutions.
- Wide viewing angle to allow viewing from a sitting or standing position, or while moving from side-to-side.
- Wireless charging stand base, designed for Qi/PMA compliance*, makes wireless charging possible for your smartphones or mobile devices.
- Plug and play capability if supported by your system.
- VGA and HDMI connectivity makes it simple and easy to connect with legacy and new systems.
- Built-in Speaker (3W) x 2.
- On-Screen Display (OSD) adjustments for ease of set-up and screen optimization.
- Software and documentation media includes an Information File (INF), Image Color Matching File (ICM), and product documentation.
- Dell Display Manager Software included (in the CD shipped with the monitor).
- Security-lock slot.
- Capability to switch from wide aspect to standard aspect ratio while maintaining the image quality.
- TCO-Certified Displays.
- BFR/PVC- Reduced.
- High Dynamic Contrast Ratio (8,000,000:1).
- 0.3 W standby power when in the sleep mode.
- Energy Gauge shows the energy level being consumed by the monitor in real time (consumption from the wireless charging base is not included).



* The “Qi” symbol is a trademark of the Wireless Power Consortium; the PMA logo is a property of Power Matters Alliance, Inc.

Identifying Parts and Controls

Front View

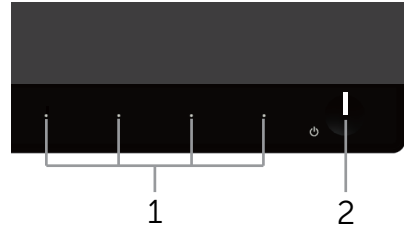

Front panel controls

Label	Description
1	Function buttons (For more information, see Operating Your Monitor)
2	Power On/Off button (with LED indicator)

 **NOTE:** For displays with glossy bezels the user should consider the placement of the display as the bezel may cause disturbing reflections from surrounding light and bright surfaces.

Back View



Back View without monitor stand

Back View with monitor stand

Label	Description	Use
1	Stand release button	Releases stand from monitor.
2	Security-lock slot	Secures monitor with security lock (security lock not included).
3	Barcode serial number label	Refer to this label if you need to contact Dell for technical support.
4	Wireless charging power switch	Turns on the switch for the readiness of wireless charging.
5	Cable management slot	Uses to organize cables by placing them through the slot.
6	DC out cable	Plugs to the power-adaptor port on the monitor, with a 12V DC power supply.
7	Power-adaptor port	Connects the power cable using a 19V DC adapter for transition.

Side View



Label	Description	Use
1	Wireless charging LED	Indicates the wireless charging status.
2	Wireless charging pad	<ul style="list-style-type: none"> Charge your Qi (WPC) or PMA compliance devices. Align your device to the pad to get max charging.

Bottom View



Bottom view without monitor stand

Label	Description	Use
1	Power-adaptor port	Connects the DC out cable of the wireless charging base.
2	Audio Line Out port	Connects external speakers (Optional Purchase) *
3	Audio Line In port	Connects the audio cable (Optional Purchase) from the source device to the monitor.
4	Regulatory label	Lists the regulatory approvals.
5	HDMI port	Connects your computer to the monitor using an HDMI cable.

6	VGA port	Connects your computer to the monitor using a VGA cable.
----------	----------	--

* Headphone usage is not supported for the audio line out port.

Plug and Play Capability

You can install the monitor in any Plug and Play-compatible system. The monitor automatically provides the computer system with its Extended Display Identification Data (EDID) using Display Data Channel (DDC) protocols so the system can configure itself and optimize the monitor settings. Most monitor installations are automatic, you can select different settings if desired. For more information about changing the monitor settings, see [Operating Your Monitor](#).

LCD Monitor Quality and Pixel Policy

During the LCD Monitor manufacturing process, it is not uncommon for one or more pixels to become fixed in an unchanging state which are hard to see and do not affect the display quality or usability. For more information on Dell Monitor Quality and Pixel Policy, see Dell Support site at: www.dell.com/support/monitors.

Maintenance Guidelines

Cleaning Your Monitor



WARNING: Before cleaning the monitor, unplug the monitor power cable from the electrical outlet.





CAUTION: Read and follow the [Safety Instructions](#) before cleaning the monitor.

For best practices, follow the instructions in the list below while unpacking, cleaning or handling your monitor:

- To clean your anti-static screen, lightly dampen a soft, clean cloth with water. If possible, use a special screen-cleaning tissue or solution suitable for the anti-static coating. Do not use benzene, thinner, ammonia, abrasive cleaners or compressed air.
- Use a lightly-dampened, warm cloth to clean the monitor. Avoid using detergent of any kind as some detergents leave a milky film on the monitor.
- If you notice white powder when you unpack your monitor, wipe it off with a cloth.
- Handle your monitor with care as a darker-colored monitor may get scratched and show white scuff marks more than a lighter-colored monitor.
- To help maintain the best image quality on your monitor, use a dynamically changing screen saver and turn Off your monitor when not in use.

Setting Up the Monitor

Connecting the Stand

-  **NOTE:** The stand is detached when the monitor is shipped from the factory.
-  **NOTE:** The following steps are applicable for a monitor with a stand.

To attach the monitor stand:

1. Remove the cover and place the monitor on it.
2. Insert the stand base blocks fully into the stand slot.
3. Turn the screw clockwise. After fully tightening the screw, fold the screw handle flat within the recess.
4. Fit the two tabs on the upper part of the stand to the groove on the back of the monitor.
5. Press the stand till it snaps into place.

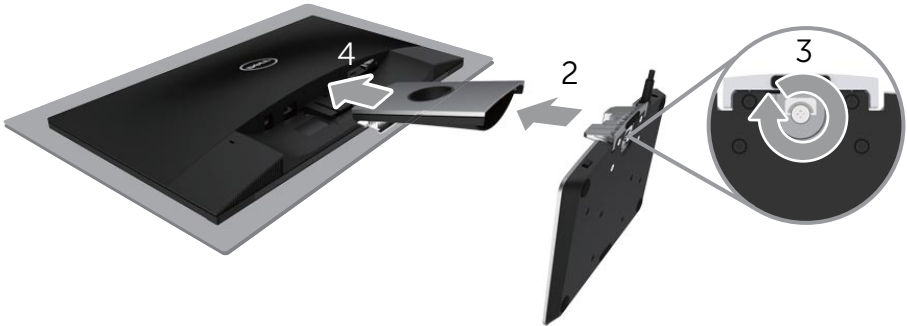

Connecting Your Monitor

⚠ WARNING: Before you begin any of the procedures in this section, follow the [Safety Instructions](#).

📌 NOTE: Do not connect all cables to the computer at the same time.

To connect your monitor to the computer:

1. Turn Off your computer and disconnect the power cable.
2. Connect the VGA/HDMI/audio cable from your monitor to the computer.
3. Plug the DC out cable of the wireless charging base to the power adapter port on the monitor. And plug the supplied power cable with 19V DC adapter to the power adapter port on the wireless charging base.

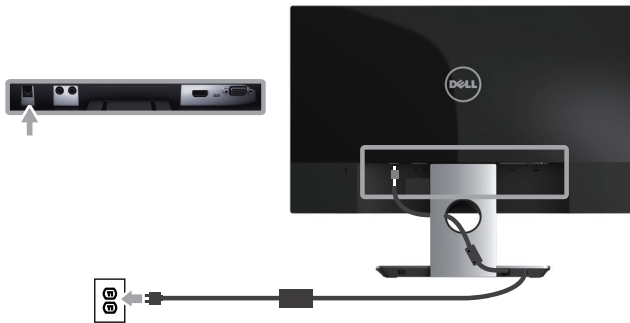

Connecting the VGA cable (Optional Purchase)

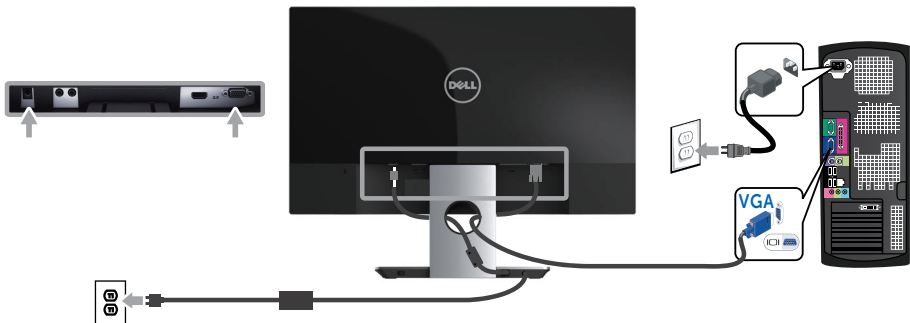

Connecting the HDMI cable

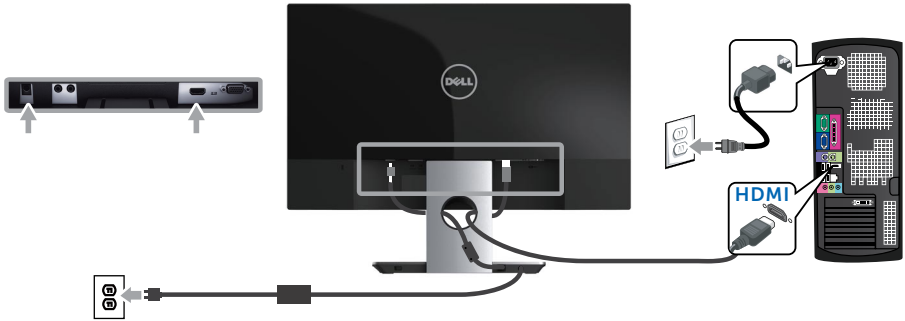

Connecting the audio cable (Optional Purchase)



Organizing Cables



After you connect all necessary cables to your monitor and computer, organize all cables as shown above.

 **NOTE:** After the cables are connected, they will have to be disconnected again to route them through the hole.

Removing the Monitor Stand

 **NOTE:** To prevent scratches on the LCD screen while removing the stand, ensure that the monitor is placed on a soft and clean surface.

 **NOTE:** The following steps are applicable for a monitor with a stand.

To remove the stand:

1. Place the monitor on a soft cloth or cushion.
2. Use a long and thin screwdriver to push the release latch.
3. Once the latch is released, remove the stand away from monitor.



Operating Your Monitor

Power On the Monitor

Press the  button to turn On the monitor.





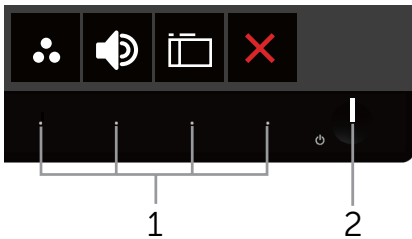

Using the Front Panel Controls

Use the control buttons on the front of the monitor to adjust the image being displayed.



The following table describes the front panel buttons:

	Front Panel Button	Description
1	 Shortcut key/Preset Modes	Use this button to choose from a list of preset modes.
	 Shortcut key/Volume	Use the buttons to adjust the volume. Minimum is 0 (-). Maximum is 100 (+).
	 Menu	Use the Menu button to launch the On-Screen Display (OSD) and select the OSD Menu. See Accessing the OSD menu .
	 Exit	Use this button to go back to the main menu or exit the OSD main menu.

2



Power On/Off button (with LED indicator)





Use the **Power** button to turn the monitor **On** and **Off**.

Solid white light indicates the monitor is On and fully functional. Blinking white light indicates the power save mode.

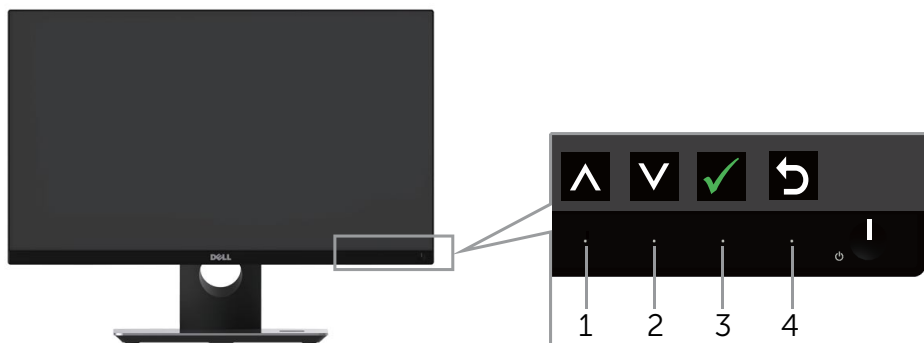
OSD controls

Use the buttons on the front of the monitor to adjust the image settings.



Front Panel Button	Description
1  Up	Use the Up button to increase values or move up.
2  Down	Use the Down button to adjust (decrease ranges) items in the OSD menu.
3  OK	Use the OK button to confirm your selection.
4  Back	Use the Back button to go back to the previous menu.

Using the On-Screen Display (OSD) Menu







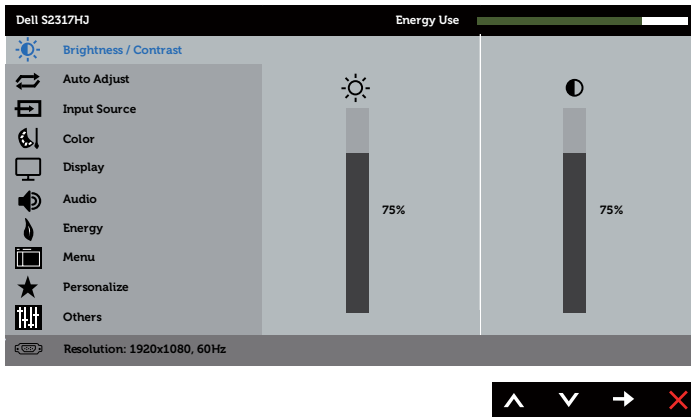

Accessing the OSD menu





 **NOTE:** If you change the settings and then either proceed to another menu or exit the OSD menu, the monitor automatically saves those changes. The changes are also saved if you change the settings and then wait for the OSD menu to disappear.

1. Press the  button to display the OSD main menu.

Main Menu for analog (VGA) input

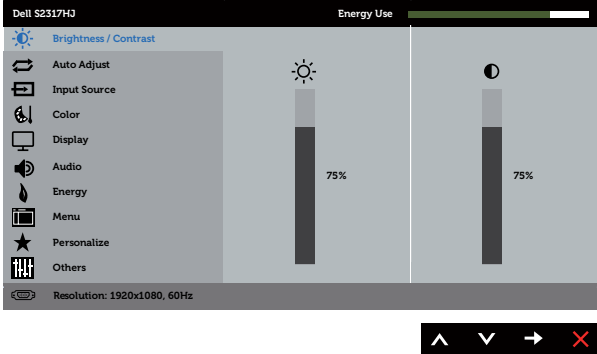

2. Press the  and  buttons to move between the setting options. As you move from one icon to another, the option name is highlighted. See the following table for a complete list of all the options available for the monitor.
3. Press the  button once to activate the highlighted option.
4. Press  and  button to select the desired parameter.
5. Press  and then use the  and  buttons, according to the indicators on the menu, to make your changes.
6. Select the  button to return to the main menu.

Icon	Menu and Submenus	Description
	Brightness/ Contrast	<p>Use this menu to activate Brightness/Contrast adjustment.</p> 
	Brightness	<p>Brightness adjusts the luminance of the backlight.</p> <p>Press the  button to increase the brightness and press the  button to decrease the brightness (min. 0 / max. 100).</p> <p>NOTE: Manual adjustment of Brightness is disabled when Dynamic Contrast is switched On.</p>
	Contrast	<p>Adjust the Brightness first, and then adjust the Contrast only if further adjustment is necessary.</p> <p>Press the  button to increase the contrast and press the  button to decrease the contrast (min. 0 / max. 100).</p> <p>The Contrast function adjusts the degree of difference between darkness and lightness on the monitor screen.</p>



Auto Adjust

Use this key to activate automatic setup and adjust menu.

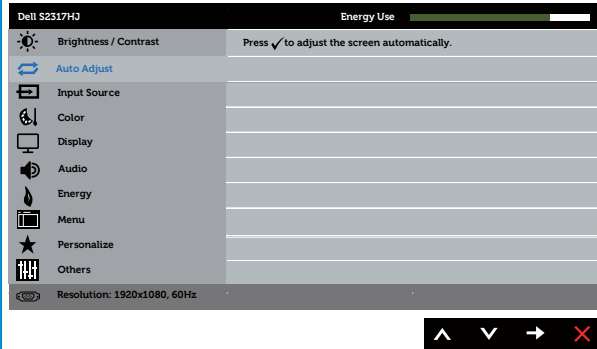

The following dialog appears on a black screen as the monitor self-adjusts to the current input:

Auto Adjustment in Progress...

Auto Adjustment allows the monitor to self-adjust to the incoming video signal. After using Auto Adjustment, you can further tune your monitor by using the Pixel Clock (Coarse) and Phase (Fine) controls under Display Settings.

NOTE: Auto Adjust does not occur if you press the button while there are no active video input signals or attached cables.

This option is only available when you are using the analog (VGA) connector.



Input Source

Use the Input Source menu to select between the different video signals that may be connected to your monitor.

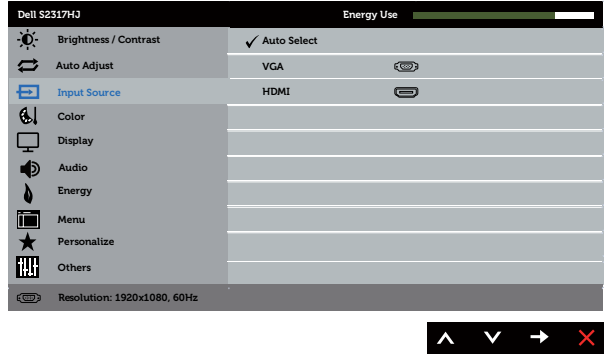

Auto Select

Select Auto Select to scan for available input signals.

VGA

Select VGA input when you are using the analog (VGA) connector. Push to select the VGA input source.

HDMI

Select HDMI input when you are using the Digital (HDMI) connector. Push to select the HDMI input source.



Color

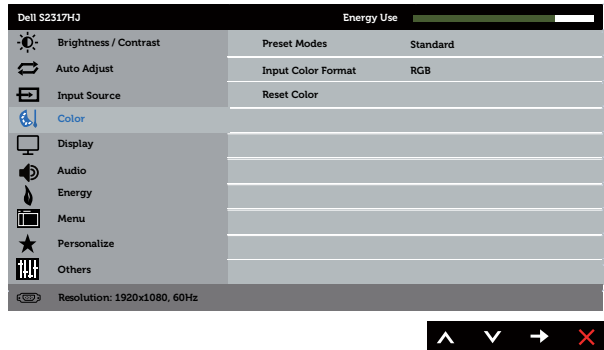

Use Color to adjust the color setting mode.









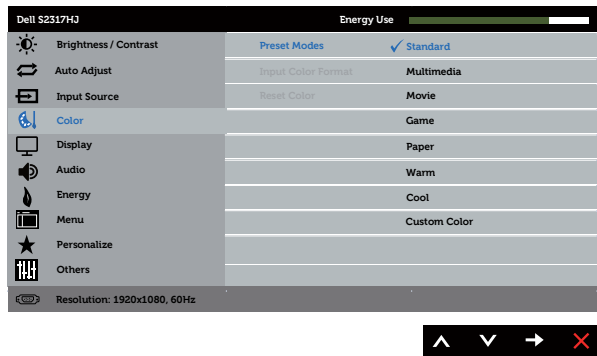

Preset Modes

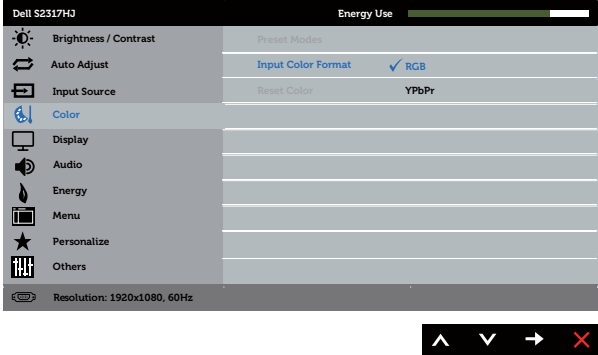
When you select Preset Modes, you can choose Standard, Multimedia, Movie, Game, Paper, Warm, Cool, or Custom Color from the list.

- Standard: Loads the monitor's default color settings. This is the default preset mode.
- Multimedia: Loads color settings ideal for multimedia applications.
- Movie: Loads color settings ideal for movies.
- Game: Loads color settings ideal for most gaming applications.
- Paper: Loads brightness and sharpness settings ideal for viewing text. Blend the text background to simulate paper media without affecting color images. Applies to RGB input format only.
- Warm: Increases the color temperature. The screen appears warmer with a red/yellow tint.
- Cool: Decreases the color temperature. The screen appears cooler with a blue tint.
- Custom Color: Allows you to manually adjust the color settings.

Press the  and  buttons to adjust the three colors (R, G, B) values and create your own preset color mode.



<p>Input Color Format</p>	<p>Allows you to set the video input mode to:</p> <ul style="list-style-type: none"> • RGB: Select this option if your monitor is connected to a computer or DVD player using the HDMI cable. • YPbPr: Select this option if your DVD player supports only YPbPr output.  <p>The screenshot shows the Dell S2317H3 OSD menu. The 'Input Color Format' option is highlighted in blue and set to 'RGB'. Other options include 'Reset Color' (set to 'YPbPr'), 'Brightness / Contrast', 'Auto Adjust', 'Input Source', 'Color', 'Display', 'Audio', 'Energy', 'Menu', 'Personalize', and 'Others'. The resolution is shown as 1920x1080, 60Hz. Navigation arrows are visible at the bottom right.</p>
<p>Hue</p>	<p>This feature can shift the color of the video image to green or purple. This is used to adjust the desired flesh tone color. Use  or  to adjust the hue from 0 to 100.</p> <p>Press  to increase the green shade of the video image.</p> <p>Press  to increase the purple shade of the video image.</p> <p>NOTE: Hue adjustment is available only when you select Movie or Game preset mode.</p>
<p>Saturation</p>	<p>This feature can adjust the color saturation of the video image. Use  or  to adjust the saturation from 0 to 100.</p> <p>Press  to increase the colorful appearance of the video image.</p> <p>Press  to increase the monochrome appearance of the video image.</p> <p>NOTE: Saturation adjustment is available only when you select Movie or Game preset mode.</p>
<p>Reset Color</p>	<p>Allows your monitor color settings to the factory settings.</p>



Display

Use the Display to adjust image.

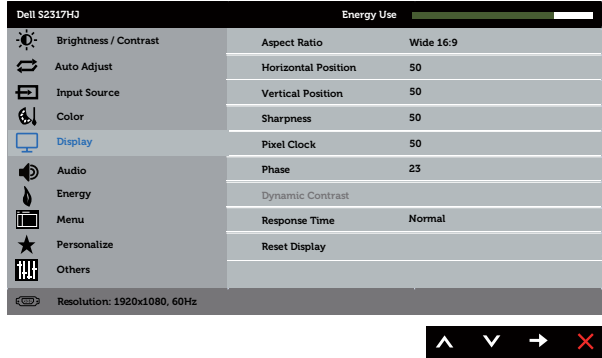

Aspect Ratio

Adjusts the image ratio to Wide 16:9, 4:3 or 5:4.

Horizontal Position

Use or the buttons to adjust image left and right. Minimum is 0 (-). Maximum is 100 (+).

Vertical Position

Use the or buttons to adjust image up and down. Minimum is 0 (-). Maximum is 100 (+).

Sharpness

This feature can make the image look sharper or softer. Use or to adjust the sharpness from 0 to 100.

Pixel Clock

The Phase and Pixel Clock adjustments allow you to adjust your monitor to your preference. Use or buttons to adjust for best image quality. Minimum is 0 (-). Maximum is 100 (+).

Phase

If satisfactory results are not obtained using the Phase adjustment, use the Pixel Clock (coarse) adjustment and then use Phase (fine), again. Minimum is 0 (-). Maximum is 100 (+).

Dynamic Contrast

Allows you to increase the level of contrast to provide sharper and more detailed image quality.

Press the button to select the Dynamic Contrast "On" or "Off".



NOTE: Dynamic Contrast provides higher contrast if you select Game or Movie preset mode.



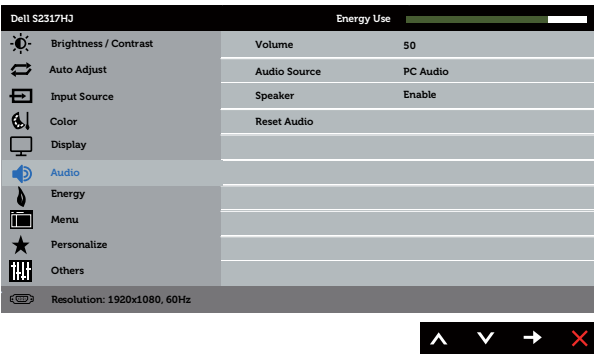

Response Time

User can select between Fast or Normal.

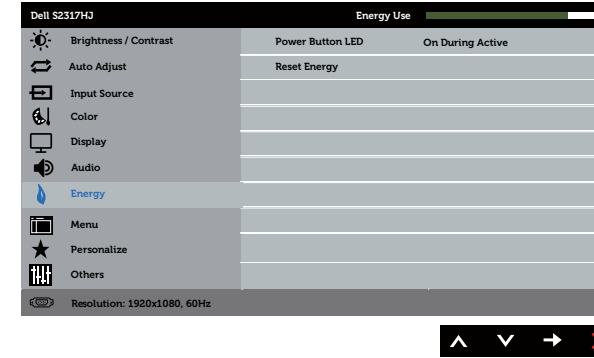
Reset Display

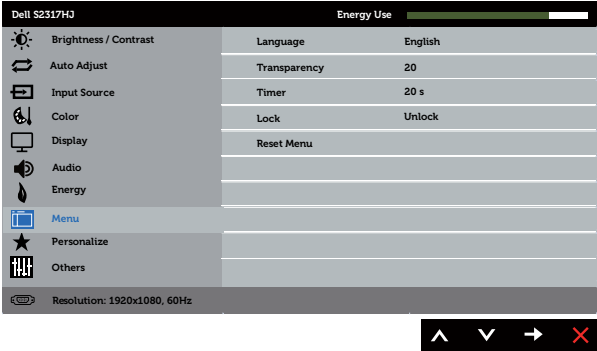
Select this option to restore default display settings.

	Audio	
	Volume	Use the buttons to adjust the volume. Minimum is 0 (-). Maximum is 100 (+).
	Audio Source	Allows you to set the Audio Source mode to: <ul style="list-style-type: none"> • PC Audio • HDMI
	Speaker	Allows you to enable or disable speaker function.
	Reset Audio	Select this option to restore default display settings.
	Energy	
	Power Button LED	Allows you to set the power LED indicator On During Active or Off During Active to save energy.
	Reset Energy	Select this option to restore default Energy settings.

	<p>Menu</p>	<p>Select this option to adjust the settings of the OSD, such as, the languages of the OSD, the amount of time the menu remains on screen and so on.</p> 
	<p>Language</p>	<p>Language options set the OSD display to one of the eight languages (English, Spanish, French, German, Brazilian Portuguese, Russian, Simplified Chinese, or Japanese).</p>
	<p>Transparency</p>	<p>Select this option to change the menu transparency by pressing the  and  buttons from 0 to 100.</p>
	<p>Timer</p>	<p>OSD Hold Time: sets the length of time the OSD will remain active after the last time you pressed a button.</p> <p>Use  or  to adjust the slider in 1 second increments, from 5 to 60 seconds.</p>
	<p>Lock</p>	<p>Controls user access to adjustments. When Lock is selected, no user adjustments are allowed. All buttons are locked.</p> <p>NOTE:</p> <ul style="list-style-type: none"> • Lock – Either soft lock (through the OSD menu) or hard lock (press and hold the button beside the power button for 10 seconds) • Unlock – Only hard unlock (press and hold the button beside the power button for 10 seconds)
	<p>Reset Menu</p>	<p>Reset all OSD settings to the factory preset values.</p>



Personalize

Users can choose a feature from Shortcut Key 1, Shortcut Key 2, Reset Personalization, Preset Modes or Brightness/ Contrast and set it as a shortcut key.

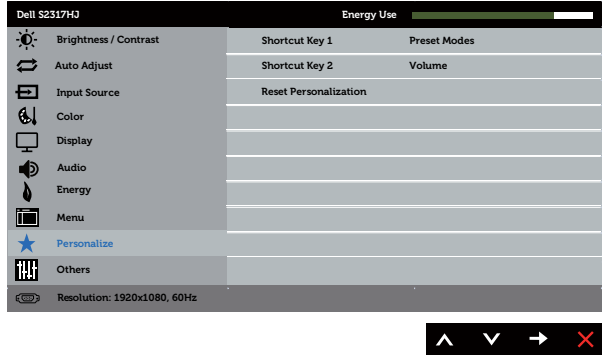

Shortcut Key 1

User can select one of the followings: Preset Modes, Brightness/Contrast, Auto Adjust, Input Source, Aspect Ratio and Volume to set the Shortcut Key 1.

Shortcut Key 2

User can select one of the followings: Preset Modes, Brightness/Contrast, Auto Adjust, Input Source, Aspect Ratio and Volume to set the Shortcut Key 2.

Reset Personalization

Allows you to restore shortcut key to the default setting.



Others

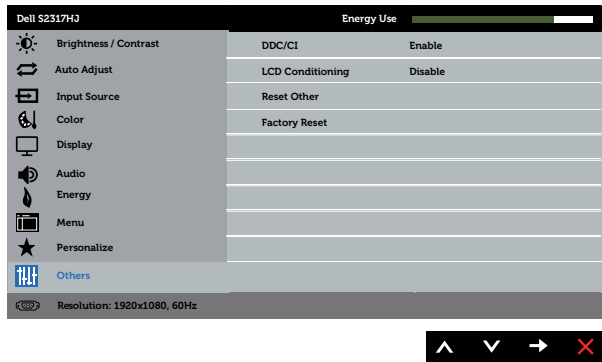

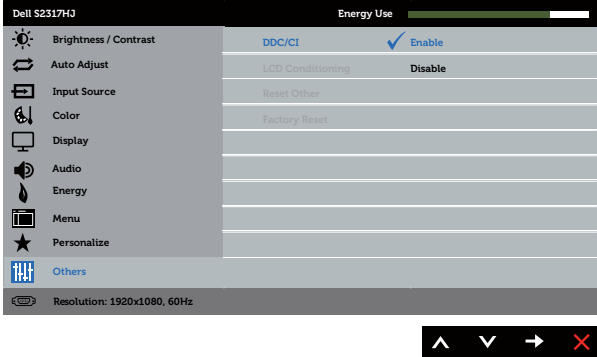
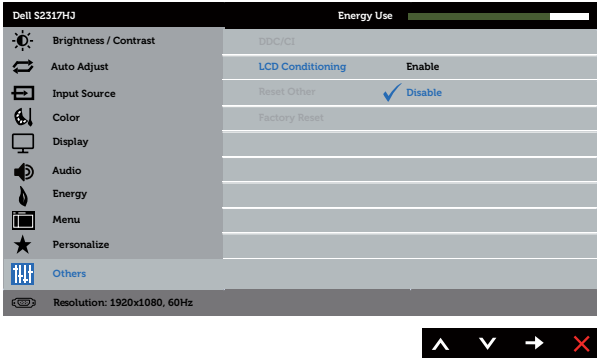
<p>DDC/CI</p>	<p>DDC/CI (Display Data Channel/Command Interface) allows your monitor parameters (brightness, color balance and etc.) to be adjustable via the software on your computer.</p> <p>You can disable this feature by selecting Disable.</p> <p>Enable this feature for best user experience and optimum performance of your monitor.</p> 
<p>LCD Conditioning</p>	<p>Helps reduce minor cases of image retention. Depending on the degree of image retention, the program may take some time to run. To start LCD conditioning, select Enable.</p> 
<p>Reset Other</p>	<p>Reset all settings under the Others setting menu to the factory preset values.</p>
<p>Factory Reset</p>	<p>Reset all settings to the factory preset values.</p>

 **NOTE:** Your monitor has a built-in feature to automatically calibrate the brightness to compensate for LED aging.

OSD Warning Messages

When the **Dynamic Contrast** feature is enabled (in these preset modes: **Game** or **Movie**), the manual brightness adjustment is disabled.

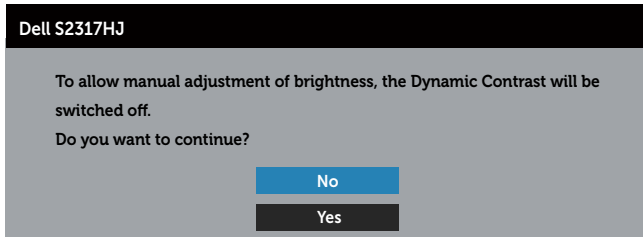

When the monitor does not support a particular resolution mode, the following message is displayed:

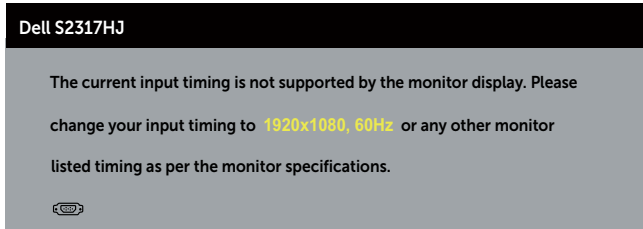

This means that the monitor cannot synchronize with the signal that it is receiving from the computer. See [Monitor Specifications](#) for the Horizontal and Vertical frequency ranges addressable by this monitor. Recommended mode is 1920 x 1080.

You will see the following message before the **DDC/CI** function is disabled:

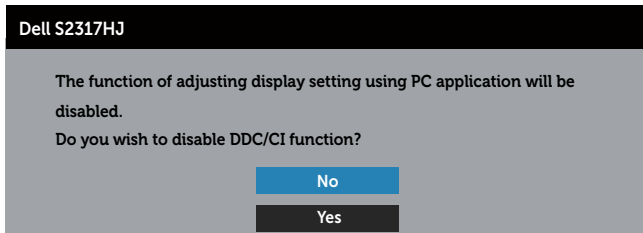

When the monitor enters the **Power Save Mode**, the following message appears:



If you press any button other than the power button, the following messages will appear depending on the selected input:

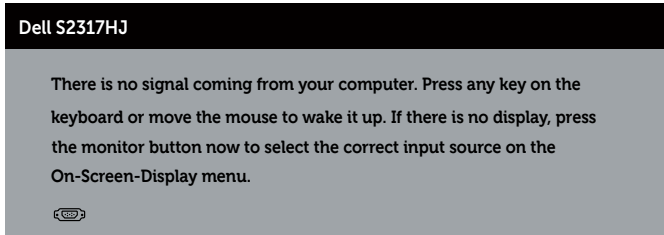

If VGA or HDMI cable is not connected, a floating dialog box as shown below appears. The monitor will enter Power Save Mode after 5 minutes if left at this state.

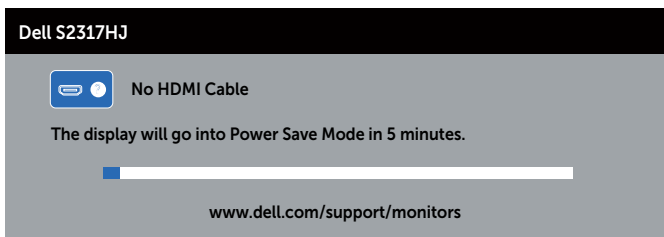
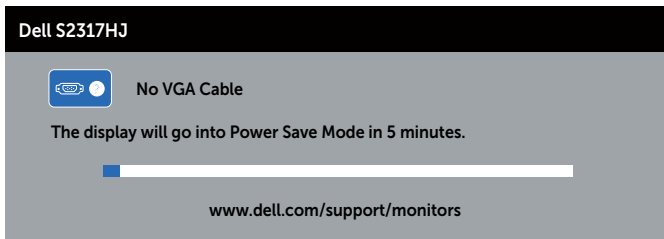

See [Troubleshooting](#) for more information.

Setting the Maximum Resolution

To set the maximum resolution for the monitor:

In Windows 7, Windows 8, Windows 8.1:

1. For Windows 8 and Windows 8.1, select the Desktop tile to switch to classic desktop.
2. Right-click on the desktop and click **Screen Resolution**.
3. Click the Dropdown list of the Screen Resolution and select **1920 x 1080**.
4. Click **OK**.

In Windows 10:

1. Right-click on the desktop and click **Display settings**.
2. Click **Advanced display settings**.
3. Click the dropdown list of **Resolution** and select **1920 x 1080**.
4. Click **Apply**.

If you do not see 1920 x 1080 as an option, you may need to update your graphics driver. Depending on your computer, complete one of the following procedures:

If you have a Dell desktop or portable computer:

- Go to www.dell.com/support, enter your service tag, and download the latest driver for your graphics card.

If you are using a non-Dell computer (portable or desktop):

- Go to the support site for your computer and download the latest graphic drivers.
- Go to your graphics card website and download the latest graphic drivers.

Using Tilt

 **NOTE:** This is applicable for a monitor with a stand. When any other stand is bought, please refer to the respective stand setup guide for set up instructions.

 **NOTE:** The stand is detached when the monitor is shipped from the factory.



Using the Wireless Charging Base

The stand base of your monitor allows you to charge a Qi (WPC)/PMA certified smartphone or mobile device wirelessly. For more information about wireless charging standards and certified devices, see www.wirelesspowerconsortium.com and www.merger.powermatters.org.

Setting Up the Wireless Charging Function

1. Ensure that the DC out cable and power cable are connected properly and secure.
2. Slide the wireless charging power switch to reveal the green color on the back. The white LED turns on for 3 seconds and then turns off to indicate that the wireless charging function is enabled.

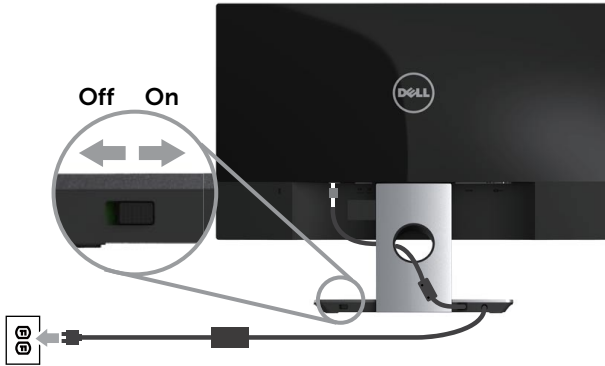

3. To turn off the wireless charging function, slide the wireless charging power switch to reveal the red color on the back.

Charging Your Mobile Device Wirelessly

To charge your mobile device wirelessly:

1. Read the documentations that shipped with the mobile device for information on how to use the wireless charging function.
2. Ensure that the charging area of the wireless charging base is clear of any object and then place your mobile device at the center of the charging area.

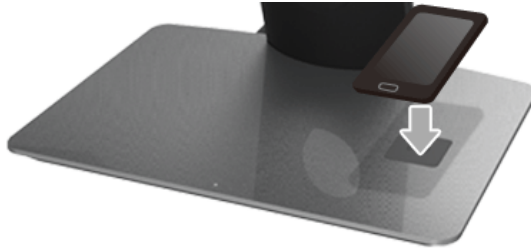

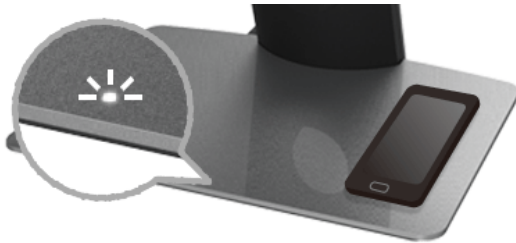

3. When the device is properly placed on the charging area, the LED turns white indicating that your device is getting charged.



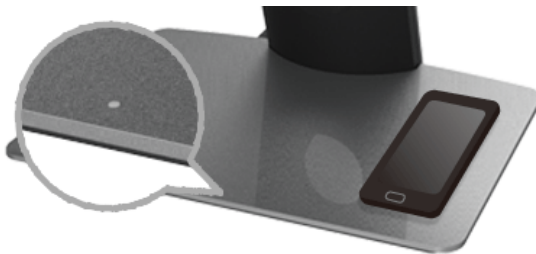

4. When the battery of the device is fully charged (usually > 98%), the white LED light turns off.



 **WARNING:** Do not charge a non Qi (WPC)/PMA certified device, or place any other object in the wireless charging area. If you use a Qi (WPC)/PMA certified wireless charging cover for the mobile device, do not place the cover in the charging area without the mobile device in it.

 **WARNING:** Do not place any magnetic storage media (like floppy disks or credit cards) near the charging area. The data on the media can get erased.

 **NOTE:** The time taken to charge the mobile device completely depends on the charge remaining on the device and it's charging efficiency.

 **NOTE:** To avoid any interference while your device is charging, do not place anything around the device and the charging area.

 **NOTE:** It is normal that the charging stand base and mobile device gets warm while charging.

 **NOTE:** The wireless charging function will be turned off if the monitor power is turned Off.

Charge status LED behavior

The following table describes the status that LED indicates:

LED Indicator	Activities
White LED lights up for 3 seconds and turns off	Wireless charging is enabled.
LED does not turn on when the device is placed in the charging area.	Not charging.
White LED	Charging.
White LED turns off	The battery of your device is fully charged.
White LED appears for 2 seconds and turns off	Notifies that the battery of your device is actually fully charged and you may want to remove it from the charging pad.

Troubleshooting

⚠ WARNING: Before you begin any of the procedures in this section, follow the [Safety Instructions](#).

Self-Test

Your monitor provides a self-test feature that allows you to check if your monitor is functioning properly. If your monitor and computer are properly connected but the monitor screen remains dark, run the monitor self-test by performing the following steps:

1. Turn off both your computer and the monitor.
2. Disconnect the video cable from the back of the computer. To ensure proper Self-Test operation, remove all digital and analog cables from the back of monitor.
3. Turn on the monitor.

If the monitor is working correctly, it detects that there is no signal and one of the following messages appears. While in self-test mode, the power LED remains white.

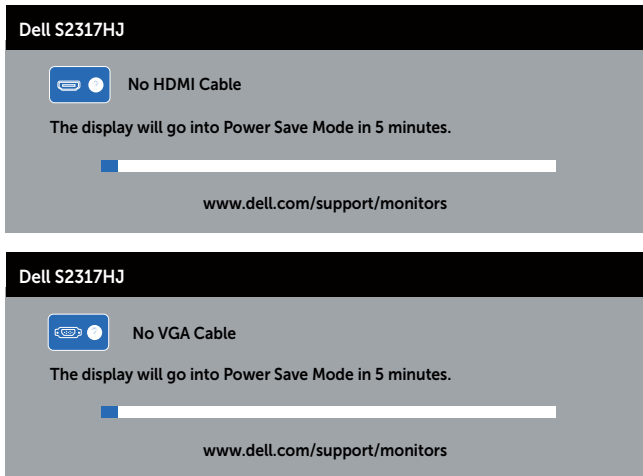

📌 NOTE: This box also appears during normal system operation, if the video cable is disconnected or damaged.

4. Turn Off your monitor and reconnect the video cable; then turn on both your computer and the monitor.

If your monitor remains dark after you reconnect the cables, check your video controller and computer, because your monitor is functioning properly.

Built-in Diagnostics

Your monitor has a built-in diagnostic tool that helps you determine if any screen abnormality you experience is an inherent problem with your monitor, or with your computer and video card.

 **NOTE:** You can run the built-in diagnostics only when the video cable is unplugged and the monitor is in *self-test mode*.

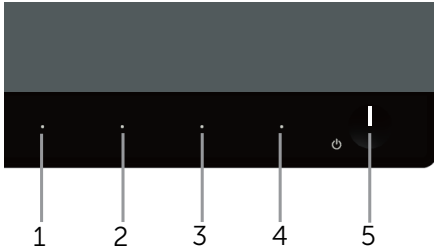

To run the built-in diagnostics:

1. Ensure that the screen is clean (no dust particles on the surface of the screen).
2. Unplug the video cable(s) from the back of the computer or monitor. The monitor then goes into the self-test mode.
3. Press and hold **Button 1** and **Button 4** simultaneously for 2 seconds. A gray screen appears.
4. Carefully inspect the screen for abnormalities.
5. Press **Button 4** on the front panel again. The color of the screen changes to red.
6. Inspect the display for any abnormalities.
7. Repeat steps 5 and 6 to inspect the display in green, blue, black, white and text screens.

The test is complete when the text screen appears. To exit, press **Button 4** again.

If you do not detect any screen abnormalities upon using the built-in diagnostic tool, the monitor is functioning properly. Check the video card and computer.

Common Problems

The following table contains general information about common monitor problems you might encounter and the possible solutions:

Common Symptoms	What You Experience	Possible Solutions
No Video/Power LED off	No picture	<ul style="list-style-type: none"> • Ensure that the video cable connecting the monitor and the computer is properly connected and secure. • Verify that the power outlet is functioning properly using any other electrical equipment. • Ensure that the correct input source is selected via the Input Source menu.
No Video/Power LED on	No picture or no brightness	<ul style="list-style-type: none"> • Increase brightness and contrast controls using the OSD. • Perform monitor self-test feature check. • Check for bent or broken pins in the video cable connector. • Run the built-in diagnostics. • Ensure that the correct input source is selected via the Input Source menu.
Poor Focus	Picture is fuzzy, blurry, or ghosting	<ul style="list-style-type: none"> • Eliminate video extension cables. • Reset the monitor to Factory Settings (Factory Reset). • Change the video resolution to the correct aspect ratio.
Shaky/Jittery Video	Wavy picture or fine movement	<ul style="list-style-type: none"> • Reset the monitor to Factory Settings (Factory Reset). • Check environmental factors. • Relocate the monitor and test in another room.
Missing Pixels	LCD screen has spots	<ul style="list-style-type: none"> • Cycle power On-Off. • Pixel that is permanently Off is a natural defect that can occur in LCD technology. • For more information on Dell Monitor Quality and Pixel Policy, see Dell Support site at http://www.dell.com/support/monitors.
Stuck-on Pixels	LCD screen has bright spots	<ul style="list-style-type: none"> • Cycle power On-Off. • Pixel that is permanently off is a natural defect that can occur in LCD technology. • For more information on Dell Monitor Quality and Pixel Policy, see Dell Support site at http://www.dell.com/support/monitors.
Brightness Problems	Picture too dim or too bright	<ul style="list-style-type: none"> • Reset the monitor to Factory Settings (Factory Reset). • Adjust brightness & contrast controls via OSD.
Geometric Distortion	Screen not centered correctly	<ul style="list-style-type: none"> • Reset the monitor to Factory Settings (Factory Reset). • Adjust horizontal & vertical controls via OSD.

Horizontal/ Vertical Lines	Screen has one or more lines	<ul style="list-style-type: none"> • Reset the monitor to Factory Settings (Factory Reset). • Perform monitor self-test feature check and determine if these lines are also in self-test mode. • Check for bent or broken pins in the video cable connector. • Run the built-in diagnostics.
Synchronization Problems	Screen is scrambled or appears torn	<ul style="list-style-type: none"> • Reset the monitor to Factory Settings (Factory Reset). • Perform monitor self-test feature check to determine if the scrambled screen appears in self-test mode. • Check for bent or broken pins in the video cable connector. • Restart the computer in the safe mode.
Safety Related Issues	Visible signs of smoke or sparks	<ul style="list-style-type: none"> • Do not perform any troubleshooting steps. • Contact Dell immediately.
Intermittent Problems	Monitor malfunctions on & off	<ul style="list-style-type: none"> • Ensure that the video cable connecting the monitor to the computer is connected properly and is secure. • Reset the monitor to Factory Settings (Factory Reset). • Perform monitor self-test feature check to determine if the intermittent problem occurs in self-test mode.
Missing Color	Picture missing color	<ul style="list-style-type: none"> • Perform monitor self-test feature check. • Ensure that the video cable connecting the monitor to the computer is connected properly and is secure. • Check for bent or broken pins in the video cable connector.
Wrong Color	Picture color not good	<ul style="list-style-type: none"> • Change the Color Setting Mode in the Color Settings OSD to Graphics or Video depending on the application. • Try different Preset Modes in Color settings OSD. Adjust R/G/B value in Custom Color in Color settings OSD. • Change the Input Color Format to RGB or YPbPr in the Color settings OSD. • Run the built-in diagnostics.
Image retention from a static image left on the monitor for a long period of time	Faint shadow from the static image displayed appears on the screen	<ul style="list-style-type: none"> • Use the Power Management feature to turn off the monitor at all times when not in use (for more information, see Power Management Modes). • Alternatively, use a dynamically changing screensaver.
Video Ghosting or Overshooting	Moving image appears to have trailing shadow or bright edge.	<ul style="list-style-type: none"> • Change the Response Time in the Display OSD to Fast or Normal depending on your application and usage.

Product-Specific Problems



Specific Symptoms	What You Experience	Possible Solutions
Screen image is too small	Image is centered on screen, but does not fill entire viewing area	<ul style="list-style-type: none"> • Check the Aspect Ratio setting in the Display settings OSD. • Reset the monitor to Factory Settings (Factory Reset) .
Cannot adjust the monitor with the buttons on the side panel	OSD does not appear on the screen	<ul style="list-style-type: none"> • Turn Off the monitor, unplug the power cord, plug it back, and then turn On the monitor. • Check if the OSD menu is locked. If yes, press and hold the button above the Power button for 10 seconds to unlock. (For more information, see Lock).
No Input Signal when user controls are pressed	No picture, the LED light is white	<ul style="list-style-type: none"> • Check the signal source. Ensure the computer is not in standby or sleep mode by moving the mouse or pressing any key on the keyboard. • Check if the video cable is plugged in properly. Disconnect and reconnect the video cable if necessary. • Reset the computer or video player.
The picture does not fill the entire screen	The picture cannot fill the height or width of the screen	<ul style="list-style-type: none"> • Due to different video formats (aspect ratio) of DVDs, the monitor may display in full screen. • Run the built-in diagnostics.

Wireless Charging Specific Problems

Specific Symptoms	What You Experience	Possible Solutions
Wireless charging is not working	No charge to the mobile device	<ul style="list-style-type: none"> • Ensure that the wireless charging function of the mobile device works properly, and that the mobile device is correctly placed in the center of the charging area. • Ensure that there is no other object between the mobile device and the charging area. • Wireless charging may not function near devices that emit strong electromagnetic energy (like a microwave oven or radio transmitter). Turn off these devices and try again.

Appendix

WARNING: Safety Instructions

-  **WARNING:** Use of controls, adjustments, or procedures other than those specified in this documentation may result in exposure to shock, electrical hazards, and/or mechanical hazards.
-  **WARNING:** For displays with glossy bezels the user should consider the placement of the display as the bezel may cause disturbing reflections from surrounding light and bright surfaces.

For information on safety instructions, see the *Product Information Guide*.

FCC Notices (U.S. Only) and Other Regulatory Information

For FCC notices and other regulatory information, see the regulatory compliance website located at www.dell.com/regulatory_compliance.

Contact Dell

For customers in the United States, call 800-WWW-DELL (800-999-3355).

-  **NOTE:** If you do not have an active Internet connection, you can find contact information on your purchase invoice, packing slip, bill, or Dell product catalog.

Dell provides several online and telephone-based support and service options. Availability varies by country and product, and some services may not be available in your area.

To get online Monitor support content:

1. Visit www.dell.com/support/monitors.

To contact Dell for sales, technical support, or customer service issues:

1. Visit www.dell.com/support.
2. Verify your country or region in the **Choose A Country/Region** drop-down menu at the bottom of the page.
3. Click **Contact Us** on the left side of the page.
4. Select the appropriate service or support link based on your need.
5. Choose the method of contacting Dell that is convenient for you.

-  **WARNING:** For displays with glossy bezels the user should consider the placement of the display as the bezel may cause disturbing reflections from surrounding light and bright surfaces.

Setting Up Your Monitor

Setting the display resolution

For maximum display performance with Microsoft Windows operating systems, set the display resolution to **1920 x 1080** pixels by performing the following steps:

In Windows 7, Windows 8, Windows 8.1:

1. For Windows 8 and Windows 8.1, select the Desktop tile to switch to classic desktop.
2. Right-click on the desktop and click **Screen Resolution**.
3. Click the Dropdown list of the Screen Resolution and select **1920 x 1080**.
4. Click **OK**.

In Windows® 10:

1. Right-click on the desktop and click **Display settings**.
2. Click **Advanced display settings**.
3. Click the dropdown list of **Resolution** and select **1920 x 1080**.
4. Click **Apply**.

If you do not see the recommended resolution as an option, you may need to update your graphics driver. Please choose the scenario below that best describes the computer system you are using, and follow the given steps.

If you have a Dell™ desktop or a Dell™ portable computer with internet access

1. Go to www.dell.com/support, enter your service tag, and download the latest driver for your graphics card.
2. After installing the drivers for your graphics adapter, attempt to set the resolution to **1920 x 1080** again.



NOTE: If you are unable to set the resolution to **1920 x 1080**, contact Dell™ to inquire about a graphics adapter that supports these resolutions.

If you have a non Dell™ desktop, portable computer, or graphics card

In Windows 7, Windows 8, Windows 8.1:

1. For Windows 8 and Windows 8.1, select the Desktop tile to switch to classic desktop.
2. Right-click on the desktop and click **Personalization**.
3. Click **Change Display Settings**.
4. Click **Advanced Settings**.

5. Identify your graphics controller supplier from the description at the top of the window (e.g. NVIDIA, ATI, Intel etc.).
6. Refer to the graphic card provider website for updated driver (for example, www.ATI.com OR www.NVIDIA.com).
7. After installing the drivers for your graphics adapter, attempt to set the resolution to **1920 x 1080** again.

In Windows 10,

1. Right-click on the desktop and click **Display settings**.
2. Click **Advanced display settings**.
3. Click the dropdown list of **Resolution** and select **1920 x 1080**.
4. Identify your graphics controller supplier from the description at the top of the window (e.g. NVIDIA, ATI, Intel etc.).
5. Refer to the graphic card provider website for updated driver (for example, www.ATI.com OR www.NVIDIA.com).
6. After installing the drivers for your graphics adapter, attempt to set the resolution to **1920 x 1080** again.



NOTE: If you are unable to set the recommended resolution, contact the manufacturer of your computer or consider purchasing a graphics adapter that will support the video resolution.

Monitor Specifications

Flat Panel Specifications

Model	S2317HJ
Screen type	Active matrix - TFT LCD
Panel type	In-plane Switching
Viewable image	
Diagonal	58.42 cm (23 in)
Horizontal, Active Area	509.18 mm (20.05 in)
Vertical, Active Area	286.41 mm (11.28 in)
Area	1458.34 cm ² (226.04 inch ²)
Pixel pitch	0.265 mm
Viewing angle (vertical / horizontal)	178° / 178° (typical)
Luminance output	250 cd/m ² (typical)
Contrast ratio	1000 to 1 (typical) 8,000,000 to 1 (Dynamic Contrast)
Faceplate coating	Low Haze with 3H hardness
Backlight	LED edgelight system
Response time	6ms gray to gray (typical)
Color depth	16.78 million colors
Color gamut	82% (typical)*

*[S2317HJ] color gamut (typical) is based on CIE1976(82%) and CIE1931(72%) test standards.

Resolution Specifications

Model	S2317HJ
Horizontal scan range	30 kHz to 83 kHz (automatic)
Vertical scan range	56 Hz to 76 Hz (automatic)
Maximum preset resolution	1920 x 1080 at 60 Hz

Preset Display Modes

Display Mode	Horizontal Frequency (kHz)	Vertical Frequency (Hz)	Pixel Clock (MHz)	Sync Polarity (Horizontal / Vertical)
VESA, 720 x 400	31.5	70.1	28.3	-/+
VESA, 640 x 480	31.5	60.0	25.2	-/-
VESA, 640 x 480	37.5	75.0	31.5	-/-
VESA, 800 x 600	37.9	60.3	40.0	+/+
VESA, 800 x 600	46.9	75.0	49.5	+/+
VESA, 1024 x 768	48.4	60.0	65.0	-/-
VESA, 1024 x 768	60.0	75.0	78.8	+/+
VESA, 1152 x 864	67.5	75.0	108.0	+/+
VESA, 1280 x 1024	64.0	60.0	108.0	+/+
VESA, 1280 x 1024	80.0	75.0	135.0	+/+
VESA, 1600 x 1200	75.0	60.0	162.0	+/+
VESA, 1920 x 1080	67.5	60.0	148.5	+/+

Electrical Specifications

Model		S2317HJ
Video input signals		<ul style="list-style-type: none"> Analog RGB, 0.7 Volts +/-5%, positive polarity at 75 ohm input impedance HDMI1.4, 600 mV for each differential line, positive polarity at 100 ohm input impedance
Synchronization input signals		Separate horizontal and vertical synchronizations, polarity-free TTL level, SOG (Composite SYNC on green)
Inrush current		120 V:30 A (Max.) 240 V:60 A (Max.)
AC/DC Adapter*	Input voltage/ frequency/ current	Delta adapter DA65NM111-00: 100 VAC to 240 VAC/50 Hz to 60 Hz \pm 3 Hz/1.6 A (Max.) Chicony adapter HA65NS5-00: 100 VAC to 240 VAC/50 Hz to 60 Hz \pm 3 Hz/1.7 A (Max)
	Output voltage/ current	Output: 19.5 V DC/3.33 A

Physical Characteristics

Model	S2317HJ
Signal cable type	<ul style="list-style-type: none"> • Digital: detachable, HDMI, 19 pins. • Analog: detachable, D-Sub, 15 pins
Dimensions (with stand)	
Height	408.1 mm (16.07 in)
Width	520.7 mm (20.50 in)
Depth	196.1 mm (7.72 in)
Dimensions (without stand)	
Height	311.6 mm (12.27 in)
Width	520.7 mm (20.50 in)
Depth	54.2 mm (2.13 in)
Stand dimensions	
Height	182.5 mm (7.19 in)
Width	262.4 mm (10.33 in)
Depth	196.1 mm (7.72 in)
Weight	
Weight with packaging	5.83 kg (12.85 lb)
Weight with stand assembly and cables	4.22 kg (9.30 lb)
Weight without stand assembly	2.90 kg (6.39 lb)
Weight of stand assembly	0.84 kg (1.85 lb)
Front frame gloss (minimum)	Black frame - 85% gloss unit

Environmental Characteristics

Model		S2317HJ
Temperature		
Operating		0°C to 40°C (32°F to 104°F)
Non-operating	Storage	<ul style="list-style-type: none"> -20°C to 60°C (-4°F to 140°F)
	Shipping	<ul style="list-style-type: none"> -20°C to 60°C (-4°F to 140°F)
Humidity		
Operating		10% to 80% (non-condensing)
Non-operating		<ul style="list-style-type: none"> Storage: 5% to 90% (non-condensing) Shipping: 5% to 90% (non-condensing)
Altitude		
Operating (maximum)		5,000 m (16,400 ft)
Non-operating (maximum)		12,192 m (40,000 ft)
Thermal dissipation		<ul style="list-style-type: none"> 150.13 BTU/hour (maximum) 78.43 BTU/hour (typical)

Power Management Modes

If you have VESA's DPM™ compliance display card or software installed in your PC, the monitor can automatically reduce its power consumption when not in use. This is referred to as Power Save Mode*. If the computer detects input from the keyboard, mouse or other input devices, the monitor automatically resumes functioning. The following table shows the power consumption and signaling of this automatic power saving feature.

* Zero power consumption in off mode can only be achieved by disconnecting the main cable from the monitor.

VESA Modes	Horizontal Sync	Vertical Sync	Video	Power Indicator	Power Consumption
Normal operation	Active	Active	Active	White	44 W (maximum)** 23 W (typical)
Active-off mode	Inactive	Inactive	Blanked	White (Glowing)	Less than 0.3 W
Switch off	-	-	-	Off	Less than 0.3 W

** Maximum power consumption with max luminance.

This document is informational only and reflects laboratory performance. Your product may perform differently, depending on the software, components and peripherals you ordered and shall have no obligation to update such information. Accordingly, the customer should not rely upon this information in making decisions about electrical tolerances or otherwise. No warranty as to accuracy or completeness is expressed or implied.

Speaker Specifications

Model	S2317HJ
Speaker rated power	2 x 3 W
Frequency Response	200 Hz - 20 kHz
Impedance	8 ohm

The OSD functions only in the normal operation mode. When any button is pressed in the Active-off mode, the following message will be displayed:

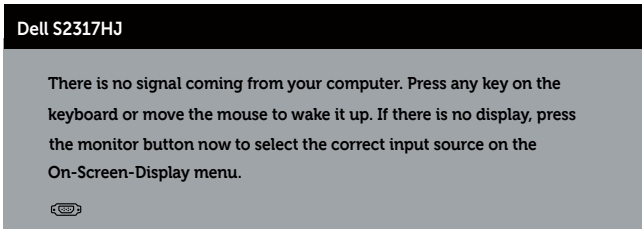

Activate the computer and the monitor to gain access to the OSD.

Pin Assignments

VGA Connector

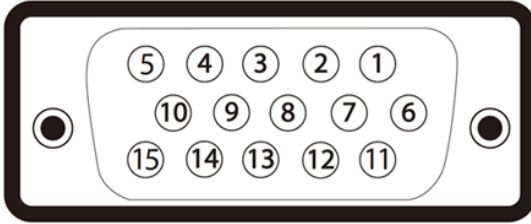

Pin Number	15-pin Side of the Connected Signal Cable
1	Video-Red
2	Video-Green
3	Video-Blue
4	GND
5	Self-test
6	GND-R
7	GND-G
8	GND-B
9	Computer 5V/3.3V
10	GND-sync
11	GND
12	DDC data
13	H-sync
14	V-sync
15	DDC clock

HDMI Connector

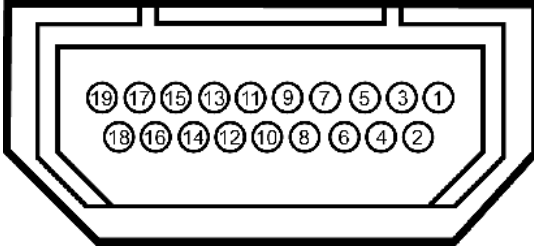

Pin Number	19-pin Side of the Connected Signal Cable
1	T.M.D.S. Data 2+
2	T.M.D.S. Data 2 Shield
3	T.M.D.S. Data 2-
4	T.M.D.S. Data 1+
5	T.M.D.S. Data 1 Shield
6	T.M.D.S. Data 1 -
7	T.M.D.S. Data 0+
8	T.M.D.S. Data 0 Shield
9	T.M.D.S. Data 0-
10	T.M.D.S. Clock +
11	T.M.D.S. Clock Shield
12	T.M.D.S. Clock -
13	CEC
14	Reserved (N.C. on device)
15	SCL
16	SDA
17	DDC/CEC Ground
18	+5V Power
19	Hot Plug Detect